

Sattelschrank

Sellerie















Saddle cabinet

Armadio per selle

#32707

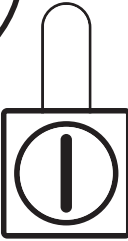
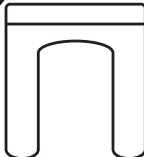
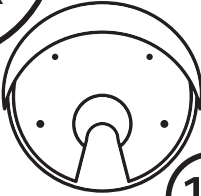
#326132

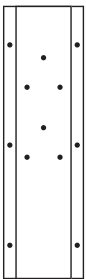

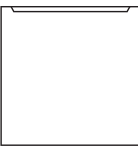
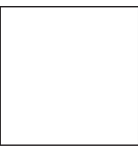
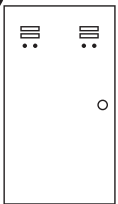
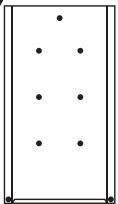
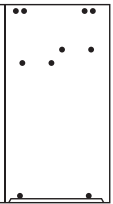
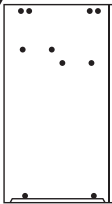
<p>14 x</p>  <p>M4</p> <p>1</p>	<p>30 x</p>  <p>M6</p> <p>2</p>	<p>14 x</p>  <p>3</p>	<p>30 x</p>  <p>4</p>
<p>10 x</p>  <p>M4x10</p> <p>5</p>	<p>4 x</p>  <p>M4x15</p> <p>6</p>	<p>29 x</p>  <p>M6x10</p> <p>7</p>	<p>2 x</p>  <p>M6x15</p> <p>8</p>
<p>2 x</p>  <p>9</p>	<p>2 x</p>  <p>10</p>	<p>1 x</p>  <p>11</p>	<p>1 x</p>  <p>12</p>
<p>2 x</p>  <p>13</p>	<p>4 x</p>  <p>14</p>	<p>1 x</p>  <p>15</p>	<p>1 x</p>  <p>16</p>
<p>1 x</p>  <p>17</p>	<p>1 x</p>  <p>18</p>	<p>1 x</p>  <p>19</p>	<p>1 x</p>  <p>20</p>
<p>1 x</p>  <p>21</p>	<p>1 x</p>  <p>22</p>		

i

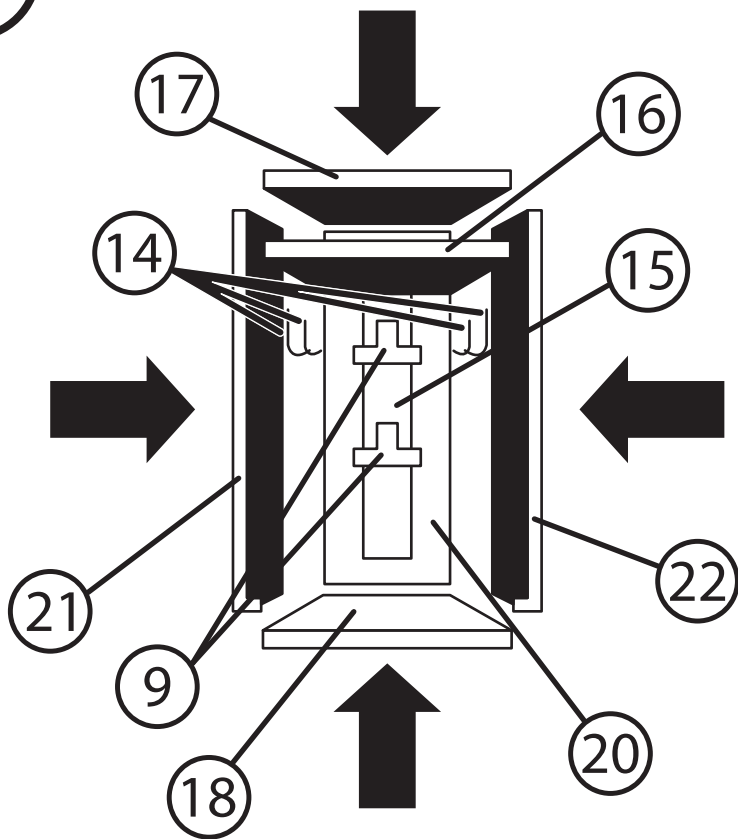

1

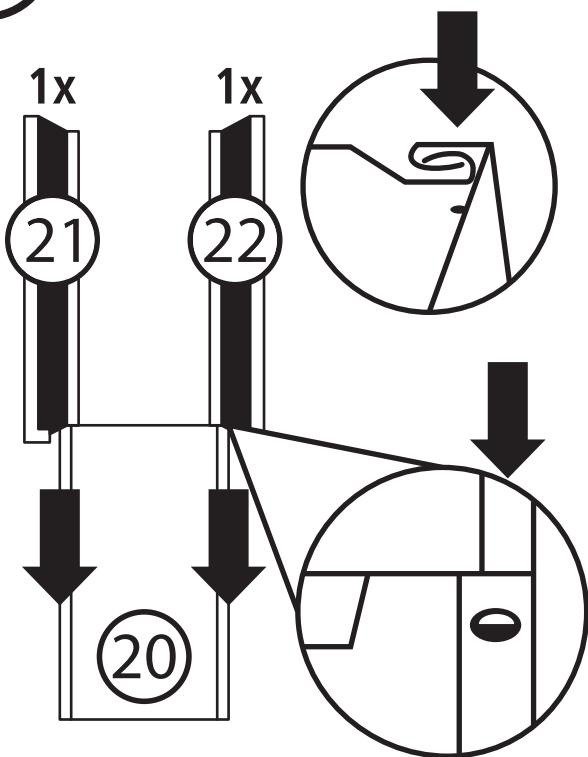

2

